

# N·E·A·R®



## High-Performance Foreground Loudspeakers

### Models S4/S4T



#### Features

- High sensitivity and exceptional power handling
- Two models: S4 for 8 ohms; S4T for 70V & 8 ohms
- 75W at 8 ohms (S4 & S4T)
- 70V Power settings: 16, 8, 4, 2, 1 watts (S4T Only)
- Hemispherical mounting system makes it simple to mount, aim, and lock-in position of loudspeaker
- 4-1/2" metal-alloy MDT™ mid/bass speaker cone is extremely stable in all environments
- Patented MLS™ Ferrofluid voice coil centering replaces distortion-causing mechanical spider and seals magnet gap
- 1" titanium high frequency driver delivers clear, articulate response and consistent long-term performance
- Wide, even coverage over listening area
- High-density, injection-molded cabinet provides an exceptional cosmetic finish
- Low-resonance cabinet structure
- Precisely designed low-frequency tuning for proper balance
- Advanced polymer compound cone surrounds resist UV rays, chemicals, and salt spray
- Aluminum-alloy & Titanium cones, UV-protected ABS cabinets, and powder-coated aluminum grilles and mounting brackets assure long-term cosmetic and sonic durability
- Pressure clamping input terminals for quick installation

#### Description

The S4 & S4T compact, versatile speakers feature NEAR's unique driver technologies to produce the highest sound quality in the most durable and reliable loudspeakers available. Precise sound reproduction is achieved with mid/bass drivers employing NEAR's MDT™ and patented MLS™ technologies for superior sound and long-term durability. The high-frequency driver is a 1" titanium diaphragm which perfectly complements the metal-alloy LF driver. A built-in 16W transformer (S4T) makes it compatible with 70V sound systems. The S4T speaker can switch between 70V or low-impedance systems by using a power tap selection switch. NEAR's patented spiderless technology (MLS™) and advanced materials deliver out-of-the-box performance year after year.

#### Unique MDT™ (Metal Diaphragm Technology):

- High rigidity and low mass of metal versus traditional papers and plastics (extremely stable cone structure over long periods of time)
- Fast transmission of sound through the diaphragm means low energy storage
- Special anodizing process creates a ceramic coating for increased stiffness
- Efficient heat-sinking of voice coils under long-term, high-power situations
- Speaker diaphragms are manufactured with materials that will not be altered by constant exposure to UV rays or water, cold or heat, or extremely high or low humidity

#### Patented MLS™ (Magnetic Liquid Suspension):

- Voice coil is constantly centered for lower distortion
- Voice coil is more efficiently heat-sunked by fluid instead of air
- Greater linearity is accomplished because the mechanical spider is eliminated
- Constant lubrication of the gap prevents oxidation from humid environments

## Technical Specifications

### Models S4/S4T

<b>Frequency Response (-10dB)*:</b>	58 Hz to 18 kHz
<b>Low-Frequency Design – Metal-Composite Cone Utilizing MLS Voice Coil Guidance System</b>	4-1/2" Nominal Dia.
<b>High-Frequency Driver – Titanium Cone:</b>	1" Nominal Dia.
<b>Sensitivity (1W/1m, Avg. 100 Hz-15 kHz):</b>	86dB SPL
<b>Dispersion</b>	
<b>Horizontal:</b>	150 Degrees
<b>Vertical:</b>	120 Degrees
<b>Impedance Ratings</b>	
<b>Low:</b>	8Ω Only (S4 version)
<b>High:</b>	70V and 8Ω (S4T version)
<b>Power Input (Maximum)</b>	75W@ 8 ohms
<b>Additional Taps:</b>	16, 8, 4, 2, 1 watts
<b>Product Weight:</b>	S4: 5 lbs. / S4T: 6 lbs.
<b>Speaker Dimensions (WxHxD)</b>	
<b>Without Bracket:</b>	5-1/4" H x 8-1/4" H x 5-3/8" D
<b>With Bracket:</b>	5-1/4" H x 8-1/4" H x 7-3/8" D
<b>Enclosure Material:</b>	ABS
<b>Product Color:</b>	White ("W" suffix) and Black ("B" suffix)
<b>Mounting Bracket Material:</b>	Aluminum Alloy, Powder-Coated Finish
<b>Grille Material:</b>	Perforated Aluminum, Powder-Coated Finish
<b>Terminations:</b>	Pressure Clamp
<b>Included Accessories:</b>	Color-Matched Mounting Bracket

\*Half-Space Response

## Architect & Engineer Specifications

The loudspeaker shall be NEAR Model S4 or S4T with a power handling capacity of 75 watts @ 8 ohms, or 16W @ 70V input (S4T), or approved equivalent. The loudspeaker shall consist of one 4-1/2 inch metal-alloy low-frequency diaphragm transducer and one 1-inch titanium high-frequency diaphragm transducer. A crossover network provides dividing and smoothing of frequencies between the transducers. A mathematically-aligned and vented molded enclosure shall house all components. High-density ABS cabinet material and powder-coated aluminum grille material will assure long-term cosmetic stability.

The high-frequency driver shall utilize a rigid titanium diaphragm and integral compounded rubber surround for proper damping and long-term reliability.

The low-frequency driver shall utilize a metal-alloy diaphragm with deep-anodized surface treatment for rigidity and corrosion resistance. The cone shall provide a heat transfer thermal path for the voice coil under high-power inputs. Compounded rubber cone surrounds shall be formulated to provide a high degree of damping and long-term performance without decay.

The voice coil will be centered via a high gauss, low viscosity magnetic fluid (Ferrofluid), which increases the heat transfer efficiency from the voice coil to the speaker's mechanical structure under long-term high-power use. The magnetic fluid shall provide corrosion resistance in the magnet gap.

The mounting bracket provided with the speaker shall be designed to provide angular movement horizontally and vertically to facilitate proper directional coverage. It shall allow both vertical and horizontal orientation of the loudspeaker. The bracket shall be formed from cast metal-alloys with a scratch-resistant, powder-coated finish. The input connectors for 8-ohm and 70V systems shall be via a positive pressure-clamping device to facilitate connection of the speaker input wires.

Dimensions of the speaker shall not exceed 5-1/4" W x 8-1/4" H x 5-3/8" D without the bracket attached; or, 5-1/4" W x 8-1/4" H x 7-3/8" D with the bracket attached. Weight shall not exceed 5 lbs. for the S4, or 6 lbs. for the S4T.

# Frequency Curves Response

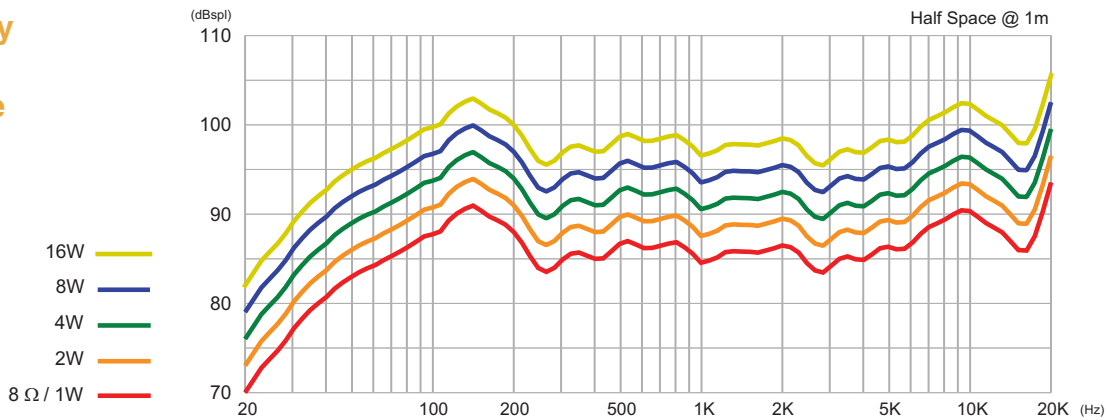

# Horizontal Polar Response

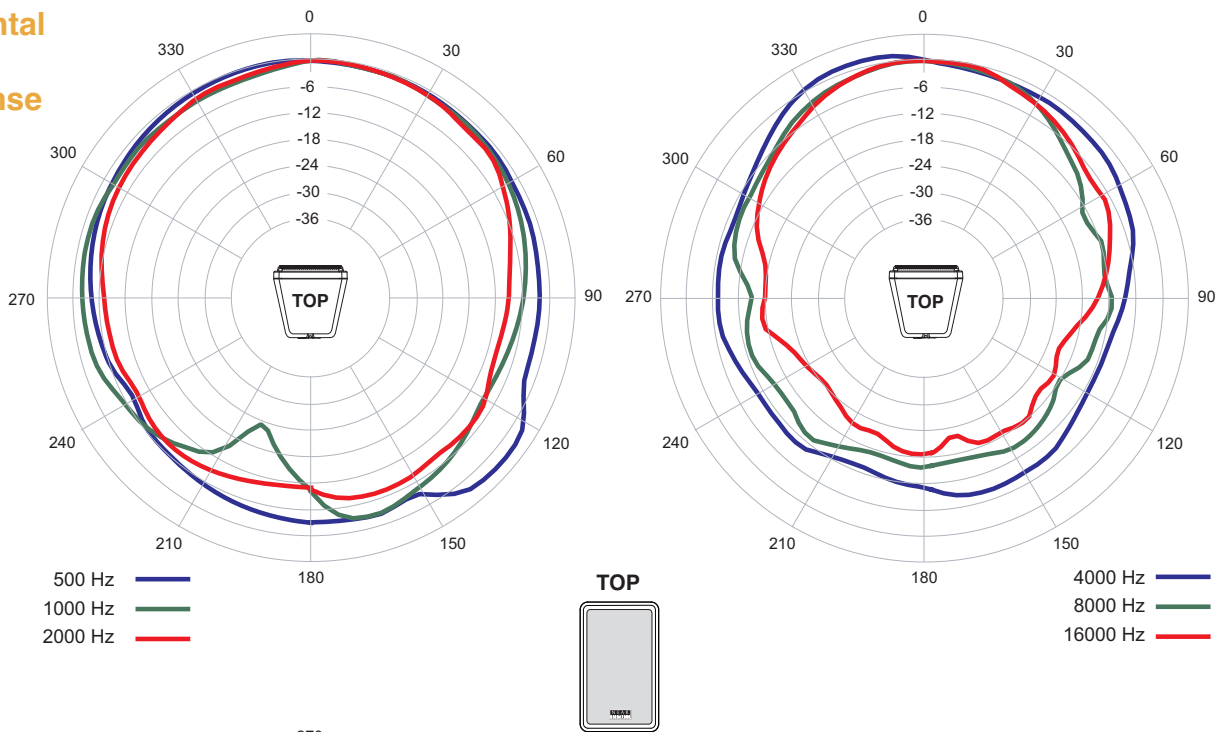

# Vertical Polar Response

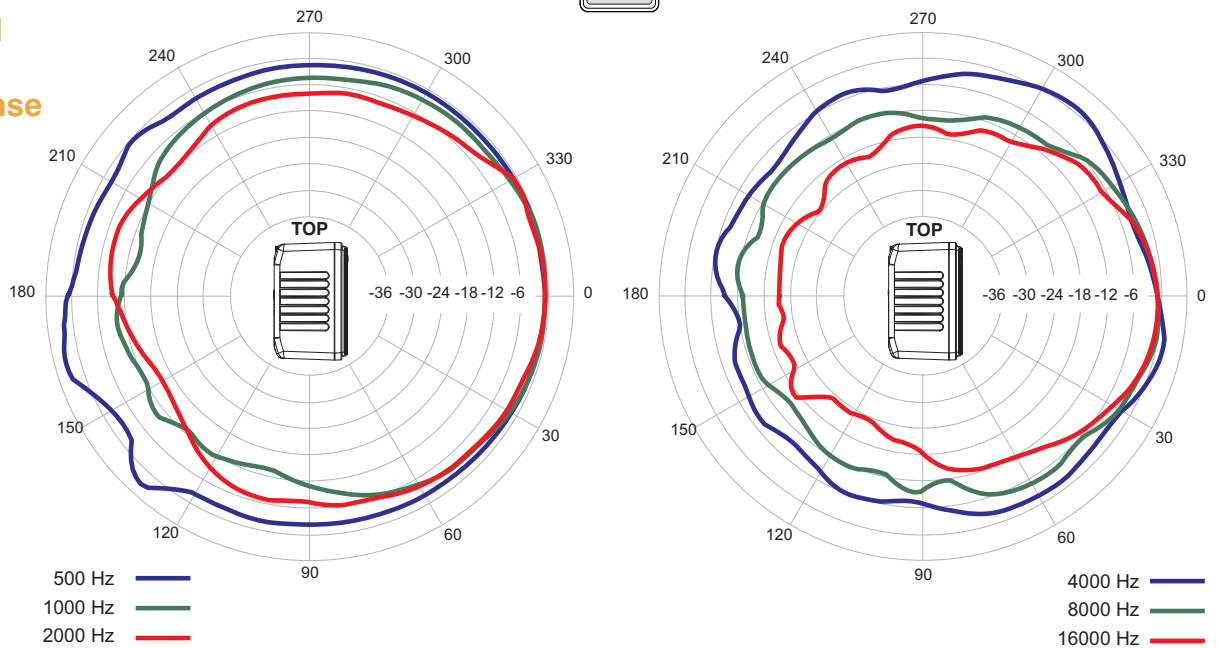

# Mechanical Drawings

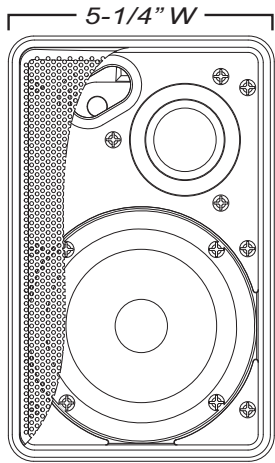

FRONT VIEW  
(Grille shown partially removed)

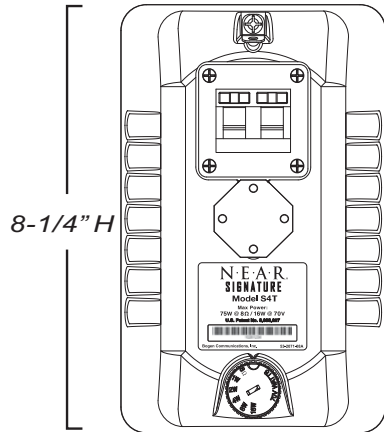

REAR VIEW  
(S4T shown, mount removed)

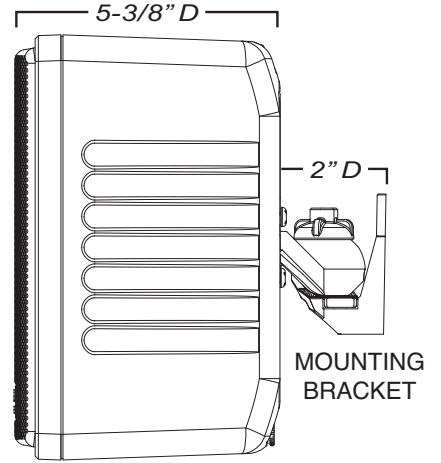

SIDE VIEW  
(Vertical Mount)

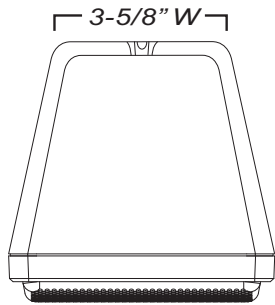

TOP VIEW

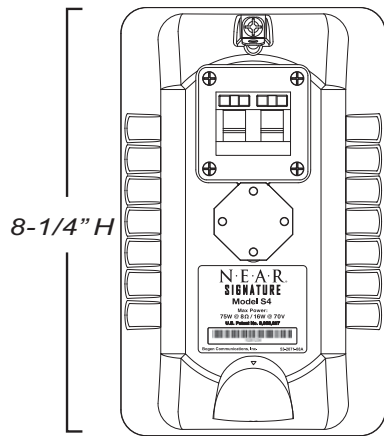

REAR VIEW  
(S4 shown, mount removed)

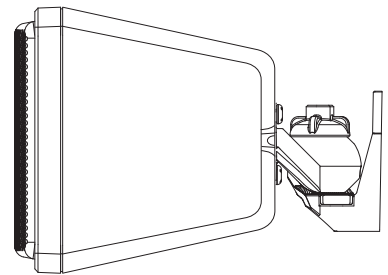

SIDE VIEW  
(Horizontal Mount)

**BOGEN**<sup>®</sup>  
**COMMUNICATIONS, INC.**

50 Spring Street, Ramsey, NJ 07446, USA  
Tel: 201-934-8500 • Fax: 201-934-9832

[www.bogen.com](http://www.bogen.com)